

SACC-MINMS-4CON-PG13 - Connector



1521339

<https://www.phoenixcontact.com/ro/produse/1521339>

Vă rugăm să țineți cont de faptul că datele afișate în acest document PDF au fost generate din catalogul nostru online. Datele complete sunt disponibile în documentația pentru utilizator. În cazul descărcărilor, se aplică Termenii și condițiile generale de utilizare ale companiei noastre.



Connector, Universal, 4-position, Plug straight 7/8"-16UNF, coding: A, Screw connection, knurl material: Zinc die-cast, nickel-plated, cable gland Pg13,5, external cable diameter 10 mm ... 12 mm, Contact 4 leading

Avantajele dumneavoastră

- Safe use in the field, thanks to a high degree of protection
- Screw connection: proven connection technology for a large selection of different conductors

Date comerciale

Număr articol	1521339
Unitate de ambalare	1 Bucată
Cantitate minimă pentru comandă	1 Bucată
Cod produs	BF2FAA
Pagina de catalog	Pagina 25 (C-2-2017)
GTIN	4017918949563
Greutate pe bucată (inclusiv ambalajul)	61,98 g
Greutate pe bucată (fără ambalaj)	51,38 g
Cod tarifar vamal	85366990
Țara de origine	DE

SACC-MINMS-4CON-PG13 - Connector



1521339

<https://www.phoenixcontact.com/ro/produse/1521339>

Date tehnice

Notes

Assembly note	NOTE: Observe the permissible bending radii when laying conductors, since the degree of protection may be put in jeopardy if the bending forces are too high. Alleviate mechanical loads upstream of the connector, e.g. by using cable ties.
---------------	--

Mounting

Assembly note	The wires can be connected both with ferrules and without ferrules
---------------	--

Product properties

Product type	Circular connector (cable-side)
Sensor type	Universal
Number of positions	4
No. of cable outlets	1
Shielded	no
Coding	A
Pg screw connection	Pg13,5

Data management status

Article revision	04
------------------	----

Insulation characteristics

Overvoltage category	III
Degree of pollution	3

Dimensions

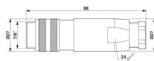
Dimensional drawing	
Width	27 mm
Height	27 mm
Length	88 mm

External dimensions

Outside diameter	10 mm ... 12 mm
------------------	-----------------

Housing

Diameter housing	27 mm
------------------	-------

Material specifications

Flammability rating according to UL 94	HB
Material of grip body	PBT
Contact material	CuZn

SACC-MINMS-4CON-PG13 - Connector



1521339

<https://www.phoenixcontact.com/ro/produse/1521339>

Contact surface material	Au
Contact carrier material	PUR/PA 6.6
Material for screw connection	Zinc die-cast, nickel-plated

Connection data

Conductor connection

Connection method	Screw connection
Connection cross section	0.34 mm ² ... 1.5 mm ² (without ferrule)
	0.34 mm ² ... 1.5 mm ² (with ferrule)
	0.34 mm ² ... 1.5 mm ² (solid)
Connection cross section AWG	22 ... 16 (without ferrule)
	22 ... 16 (with ferrule)
Stripping length of the individual wire	7 mm
Tightening torque	0.8 Nm (7/8" connectors)
	0.4 Nm (Screw terminal blocks)
	1 Nm ... 1.4 Nm (Pressure screw)

Electrical properties

Rated surge voltage	4 kV
Contact resistance	≤ 5 mΩ
Insulation resistance	≥ 100 MΩ
Nominal voltage U _N	300 V AC
	300 V DC
Nominal current I _N	9 A

Mechanical properties

Mechanical data

Insertion/withdrawal cycles	≥ 100
-----------------------------	-------

Connector

Connection 1

Head design	Plug
Head cable outlet	straight
Head thread type	7/8"-16UNF
Coding	A

Cable/line

Signal type/category	Universal
Stripping length of the individual wire	7 mm

Environmental and real-life conditions

Ambient conditions

Degree of protection	IP67
----------------------	------

SACC-MINMS-4CON-PG13 - Connector



1521339

<https://www.phoenixcontact.com/ro/produse/1521339>

Ambient temperature (operation)

-25 °C ... 85 °C (Plug / socket)

SACC-MINMS-4CON-PG13 - Connector

1521339

<https://www.phoenixcontact.com/ro/produse/1521339>

Desene

Dimensional drawing

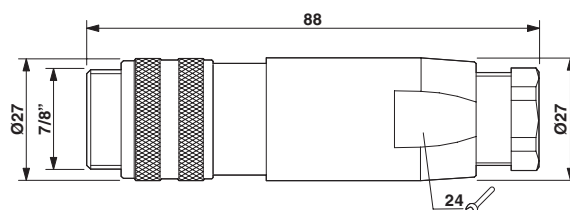

Plug $7/8"$ -16UNF, straight, Pg13

Functional drawing

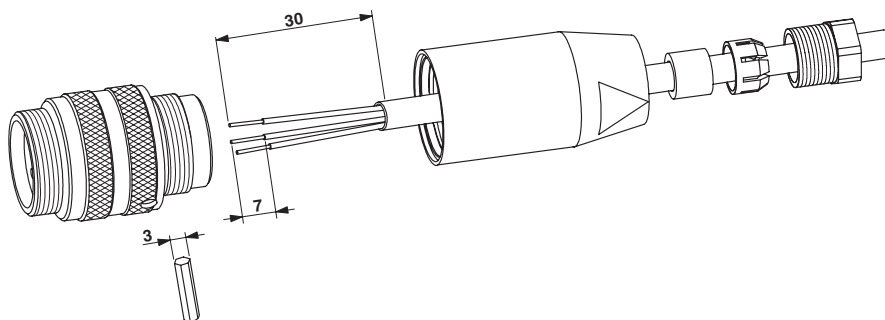

SACC-MINMS-4CON-PG13 - Connector

1521339

<https://www.phoenixcontact.com/ro/produse/1521339>



Schematic diagram

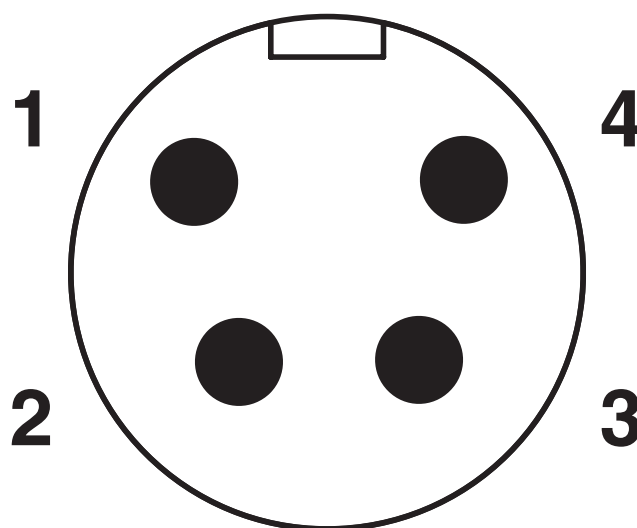

Pin assignment, plug, 7/8"-16UNF, 4-pos., view of male side

SACC-MINMS-4CON-PG13 - Connector





1521339

<https://www.phoenixcontact.com/ro/produse/1521339>

Aprobări

To download certificates, visit the product detail page: <https://www.phoenixcontact.com/ro/produse/1521339>

 cUL Recognized ID de înregistrare: FILE E 221474				
	Tensiune nominală U_N	Curent nominal I_N	Secțiune transversală AWG	Secțiune transversală mm^2
	600 V	9 A	-	-

 UL Recognized ID de înregistrare: FILE E 221474				
	Tensiune nominală U_N	Curent nominal I_N	Secțiune transversală AWG	Secțiune transversală mm^2
	600 V	9 A	-	-

 EAC ID de înregistrare: RU C-DE.BL08.B.00511				
--	--	--	--	--

cULus Recognized				
-------------------------	--	--	--	--

SACC-MINMS-4CON-PG13 - Connector



1521339

<https://www.phoenixcontact.com/ro/produse/1521339>

Clasificări

ECLASS

ECLASS-11.0	27440102
ECLASS-12.0	27440116
ECLASS-13.0	27440116

ETIM

ETIM 9.0	EC002635
----------	----------

UNSPSC

UNSPSC 21.0	39121400
-------------	----------

1521339

<https://www.phoenixcontact.com/ro/produse/1521339>

Environmental product compliance

EU RoHS

Îndeplinește cerințele conform directivei RoHS	Da
reglementări excepționale, dacă sunt cunoscute	6(c)

China RoHS

Environment friendly use period (EFUP)	EFUP-50
	Un tabel de declarații China RoHS legat de articol poate fi găsit în zona de descărcare a articolului respectiv la „Declarația producătorului”. Nu se emite și nu este necesar niciun tabel de declarații China RoHS pentru toate articolele EFUP-E.

EU REACH SVHC

Trimitere la substanța candidată REACH (nr. CAS)	Lead(nr. CAS: 7439-92-1)
SCIP	60c015be-9208-4052-a0ee-26de6719d2c0

SACC-MINMS-4CON-PG13 - Connector



1521339

<https://www.phoenixcontact.com/ro/produce/1521339>

Accesorii

PROT-MINFS-PA-CHAIN - Sealing cap

1430912

<https://www.phoenixcontact.com/ro/produce/1430912>

7/8" sealing cap made of plastic with fixing band, for sensor cables, for 7/8" connectors



TSD 08 SAC - Torque screwdriver

1212597

<https://www.phoenixcontact.com/ro/produce/1212597>

Torque screw driver with preset torque of 0.8 Nm, with 4 mm hexagon for accommodating SAC bits, two-component handle with non-slip grip



SACC-MINMS-4CON-PG13 - Connector

1521339

<https://www.phoenixcontact.com/ro/produce/1521339>

TSD-M 1,2NM - Torque screwdriver

1212224

<https://www.phoenixcontact.com/ro/produce/1212224>



Torque screw driver, accuracy as per EN ISO 6789 standard, adjustable from 0.3 - 1.2 Nm

TSD-M SAC-BIT ADAPTER - Adapter insert

1212600

<https://www.phoenixcontact.com/ro/produce/1212600>



Adapter bit for TSD-M...torque tools, E6.3-1/4" drive with 4 mm hexagon to accommodate SAC bits

SACC-MINMS-4CON-PG13 - Connector

1521339

<https://www.phoenixcontact.com/ro/produse/1521339>



SAC BIT MIN-D25 - Tool

1212512

<https://www.phoenixcontact.com/ro/produse/1212512>

Nut for assembling 7/8" connectors with a knurl diameter of 25 mm, with 4 mm hexagonal drive



Phoenix Contact 2024 © - Toate drepturile rezervate

<https://www.phoenixcontact.com>

PHOENIX CONTACT România

Splaiul Unirii 165 Timpuri Noi Square TNO1, Etaj 1

Bucuresti 030133

+40 21 350 88 12 - 3

sales.ro@phoenixcontact.com